

Article number: 201631G402SW

Description: E+G Flanged linear actuator
GN163.1-G40-2-SW

Measures

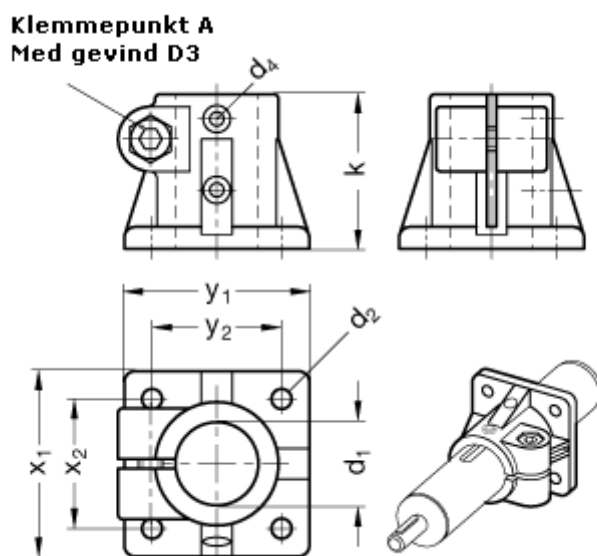

d1 = G40	y2 = 64
d2 = 8,5	
d3 = M10	
d4 = M 5	
k = 70	
x1 = 90	
x2 = 64	
y1 = 90	